

Attachment 3

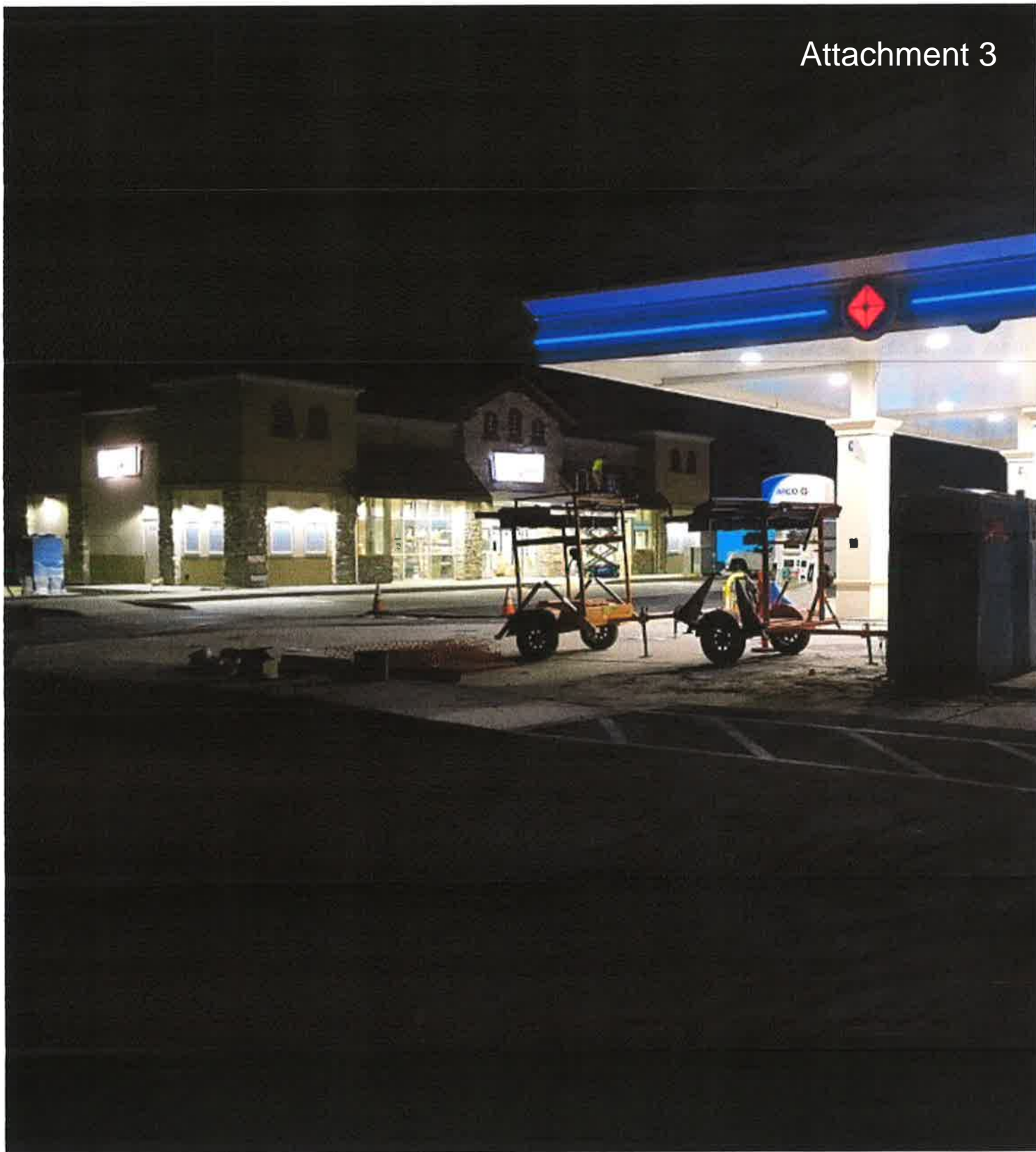

1/2" Galv. Steel angle
1-1/2" x 2" 8' (top rail tracing)

04 Pearl Alum. Angle
1.5" x 4.5" x 8' (bottom rail tracing)



ACM PEARL
COLUMN



BUILDING

ROUNDED END CAP W/ BLANK CORNER



COMBINED ARCO CHANNEL LETTERS
PANEL W/ TAPERED END CAP PANELS



ACM BULLNOSE STRIPE W/ LIGHTBAR



ACM BULLNOSE STRIPE



COMBINED ARCO SPARK PANEL W/
TAPERED END CAP PANELS



CENTER BETWEEN THE COLUMNS
INTEGRATED FASCIA ON SIDE WITH LIGHTBAR

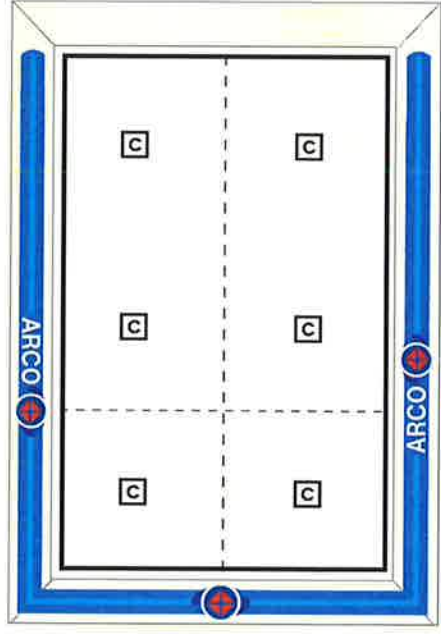

CENTER BETWEEN THE COLUMNS
INTEGRATED FASCIA ON SIDE WITH LIGHTBAR

CENTER BETWEEN THE COLUMNS
INTEGRATED FASCIA ON SIDE WITH LIGHTBAR

Approval Signature

Approved By _____ Date _____
Signoff indicates that the above product has been permitted with any municipalities involved. By signing this document, the product will be manufactured to these specifications.



Canopy Clearance Sign

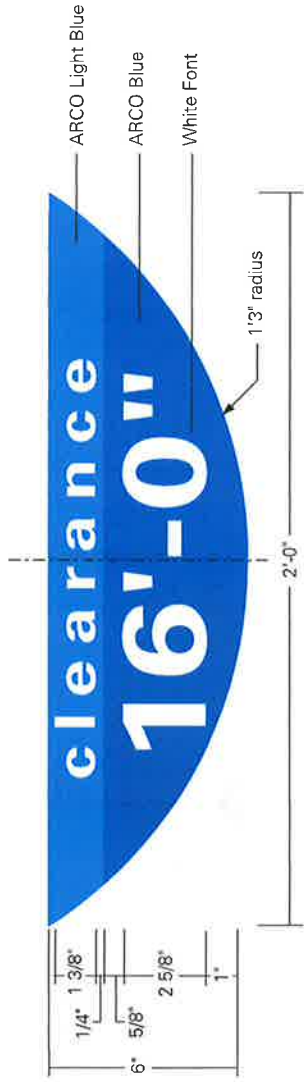

front elevation - clearance sign

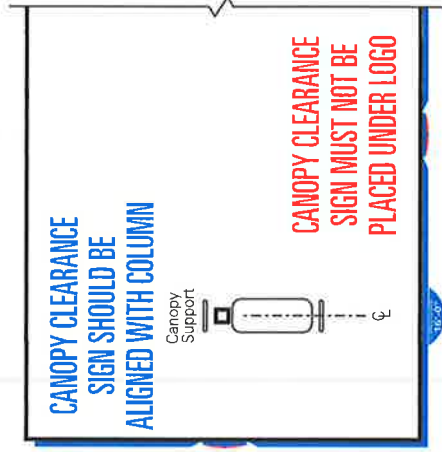

plan view - site location - Option 1

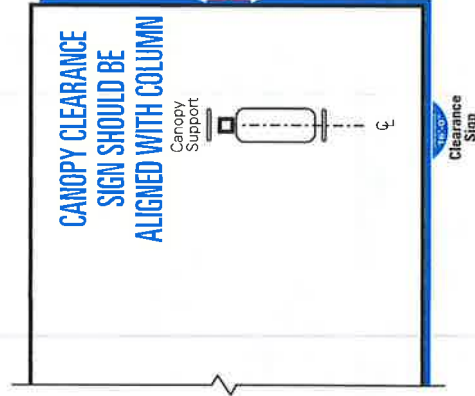

plan view - site location - Option 2



photo example - clearance sign

Canopy LED on Bullnose Decal

Pearl ACM with Bullnose Decal to return to back of fascia, covering any steps or gaps in front of fascia

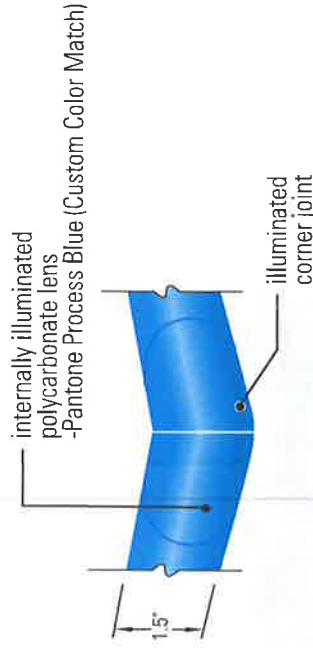
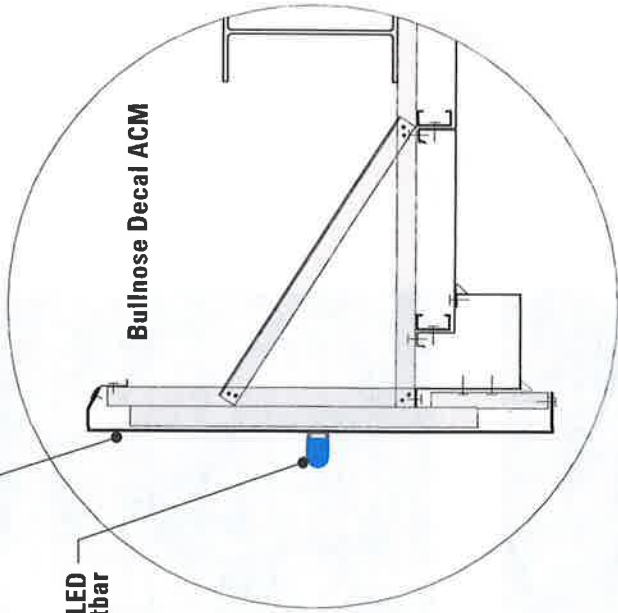

Perspective - Half-Round LED laserline

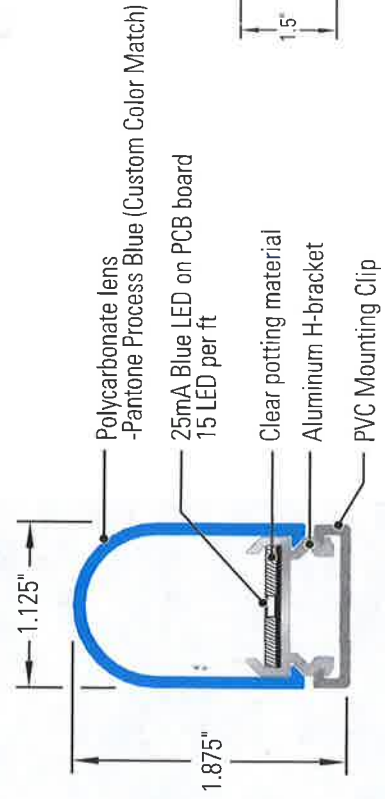

Detail - Blair LED Lightbar

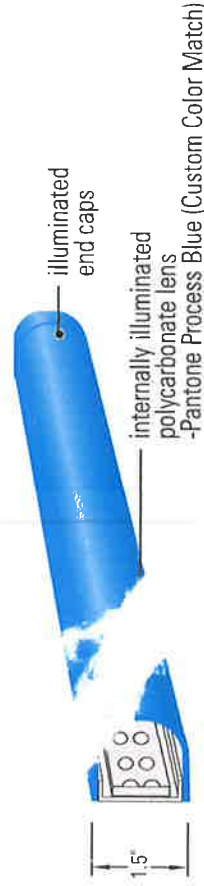

Perspective - Half-Round LED laserline